

Texture Analyzer FRTS

- FRTS quantifies texture in force (N/kgf/lbf) to evaluate the textural properties of food.
- Simple operation: Simply choose desired food (your test sample) or a test standard from the list on its touch screen, then it shows recommended measuring conditions.
- You can see test results graphically using included software.

[FRTS series]

- ◆ Simple operation by a touch screen



- ◆ Designed to combine a wide range of attachments (probes) to fit your test samples, and change them very easily.



《Calibration Certificate》



Optionally if you need, we can offer calibration certificate or traceability chart complying with Japan national standards.

*It is calibrated to force.



[Applications]

Egg (raw)	Beef (raw)	Butter	Cooked rice (Clump)	Rice gruel Universal design food
Compression	Shear	Shear	Compression	Compression

*Designed to conduct a wide range of food measurement changing attachments (probes).

[Features]

1. Simple operation
2. Easy data management and analysis
3. Easy care

Feature 1	<p>Simple operation:</p> <p>Simply choose desired food (your test sample) or a test standard from the list on its touch screen, then it shows recommended measuring conditions.</p>
------------------	--

FRTS offers 3 methods to set up measuring conditions to fit your measuring needs.

«Method 1: Select food to confirm measuring conditions»

Choose "Food/Standard."	Select your test sample from Food list.	Mount the specified attachment. (Specified attachment is indicated on its screen.)	Put a test sample on a table.
Recommended measuring conditions are indicated.	You can add Max.6 conditions to Favorite.	Start measurement.	Measured results are indicated.

Point You can edit the recommended (preset) conditions as required, and add the conditions to Favorite. You can recall them very easily from Main menu.

▪ Food list (This is excerpted version.)

Choose one from this list.

If you do not find desired food, please select a similar food or the food whose shape is similar to your sample.

Sweets	Japanese sweets	Dairy products	Butter	Noodles	Bread	Rice	Meat
Cake, pie, jelly, snack	Manju, rice cracker	Cheese, yoghurt	Butter	boiled noodles, Noodle dough	Bread, donut, kneaded dough	Uncooled rice, cooked rice	Raw meat, cooked meat
Fish and seafood	Paste	Beans	Nuts	Eggs	Vegetables	Mushrooms	Fruits
Cooked fish, raw fish	Fish sausage, paste	Cooked bean, tofu	Peanut	Egg shell, raw egg, boiled egg	Carrot, Cucumber, pepper, potato	Mushroom	Apple, Grape, jam

Point We can add 1 program according to your request (some measuring conditions are not acceptable). Please make sure to tell us before you order (Free of charge up to 1 program).

«Method 2: Select a test standard to confirm measuring conditions»

<p>Choose "Food/Standard"</p>	<p>Select a desired standard from the list. (*1)</p>	<p>Mount attachment and put your sample on table to start measurement.</p>	<p>Measurement results are indicated.</p>

*1 To perform test complying with "Food for person having difficulty in swallowing," you need a PC and its included software to show the results. Any PC is NOT included.

•List for test standards

Standards	Outlines	Measurement results
Food for person having difficulty in swallowing	Complying with required measuring method, it measures softness, cohesive property, and adherability using included software.	3-steps judgement method (Permission Criteria I / II / III)
Universal design food	It measures firmness according to required measuring method.	4-steps judgement method (Able to chew easily / able to smash with gum / able to smash with tongue / able to swallow without chew)
JIS K6503 Animal glues and gelatins	It measures firmness according to required measuring method.	Force value (N)
ISO16305 Butter	It measures firmness according to required measuring method.	Force value (N)
ISO9665 Animal glues	It measures firmness according to required measuring method.	Force value (N)
Formar JAS Special packaging for Kamaboko and the like	It measures firmness according to required measuring method.	Force value (N)

Point We can add 1 program conforming to your necessary standard (some measuring conditions are not acceptable). Please make sure to tell us before you order (Free of charge up to 1 program). *

«Method 3: Manually set up measuring conditions»

<p>Choose "Programmable Mode"</p>	<p>Select your desired measurement from "Compression Test Modes"</p>	<p>Set the condition according to your needs.</p>	<p>*You can easily recall the measuring conditions saved in Favorite.</p>

Point You can add Max.6 conditions to Favorite.

Feature 2 Easy data management and analysis:
You can easily manage data using USB flash drive* and software*. *They are included.

•You can store data into USB flash drive.



•Insert included USB flash drive into the controller.

• Touch this button
 to store data into the USB flash drive.

•Software shows test results graphically.

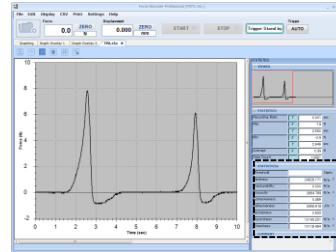

• It calculates various types of textures.

- It draws force-displacement or force-time graph.
- It draws graph in real time at Max. 1000Hz.
- Max.5 graphs can be overlaid.

•You can compare force distribution visually.

e.g.) Hamburg steak shear test

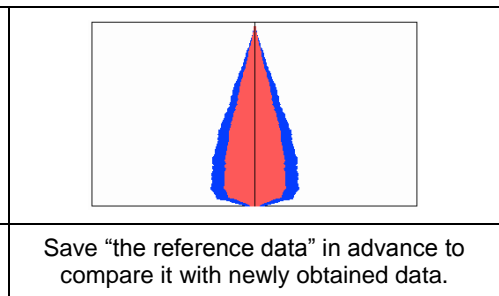
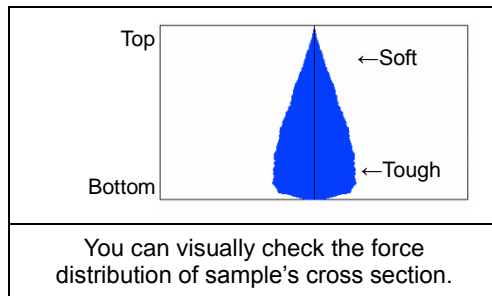

Feature 3 Easy care:
Designed to keep clean.

You can easily clean up due to stainless material.



You can easily remove the tray to clean up.



[Specifications]

Model		FRTS-5N	FRTS-50N	FRTS-100N
Capacity		5N	50N	100N
Resolution		5.000N	50.00N	100.0N
Accuracy	Force	±0.2%F.S±1digit		
	Displacement	0.1mm±1digit		
Unit	Force	N / Kg / lbf (*)		
	Displacement	mm / inch (*)		
Indication	Force	4-digit		
	Displacement	0.001mm (as the minimum resolution)		
Sampling rate		1000Hz		
Sample maximum height		70mm(*1)		
Table travel distance		Max.100mm		
Speed		0.1 to 10.0mm/sec		
Functions		3 types of measuring method (Food/Standard(*2), Program, Manual), Add-a-favorites for measuring conditions (Max.6 conditions), Start-trigger function, Overload preventing function (*3)		
Output		USB, USB flash drive		
Accessory		Graphing software, Power cable, USB cable, USB flash drive, Attachment (4 kinds), Fuse, Inspection certificate		
Operating environment (*4)		Temperature: 0 to 40 degree Celsius Humidity: 20 to 80 %RH		
Weight		Body: 7.7kg Control Panel: 0.8kg		
Size		185 x 300 x 400 mm (except its control panel)		

* The units are switchable. The units differs from Japanese domestic model.

*1 It is the maximum distance from its table surface to the part where an attachment is mounted.

*2 You need PC for measurement to comply with some standards. *3 You cannot prevent overload in some cases.

*4 You cannot use this product in a vibratile environment.



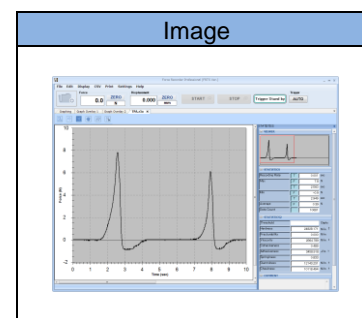

[Accessory]

- Graphing software: Force Recorder Professional(FRT Ver.)

Operating environment	Windows Vista/7/8/8.1 *32 bit only for Vista
Hardware	CPU: Pentium4 (more than or equal to 1GHz) recommended Memory: more than or equal to 2GB recommended Hard disk: more than or equal to 10GB (data storage area) needed
Plat form	.NET Framework 4 or later
Execute environment	Microsoft Internet Explorer 6.0 or later Windows installer 3.1 or later
Connection port	USB1.1, USB2.0 connector *We do not guarantee operation in USB3.0.







- 4 attachments

Disk probe FR-HA-20J	Conical probe FR-ES-2060J	Wedge probe FR-K60-2030J	Sphere probe FR-SR-20S
			

[Related Products]

•Optional attachments exclusively for FRTS

For compression test	For tension test	For shear test	Tables
			
We offer a wide range of shapes such as disks, sticks, needles and the like.	Designed for tensile tests of film, noodles, and so on.	Designed for shear tests. Knife or wedge shaped.	A table to hold containers

*These attachments above are NOT included in FRTS.

*Please refer to each specifications for detail.

*We can custom design and manufacture to meet your particular requirements. Please contact us if interested. TEL:+81-(0)532-33-3288

[Dimensions]

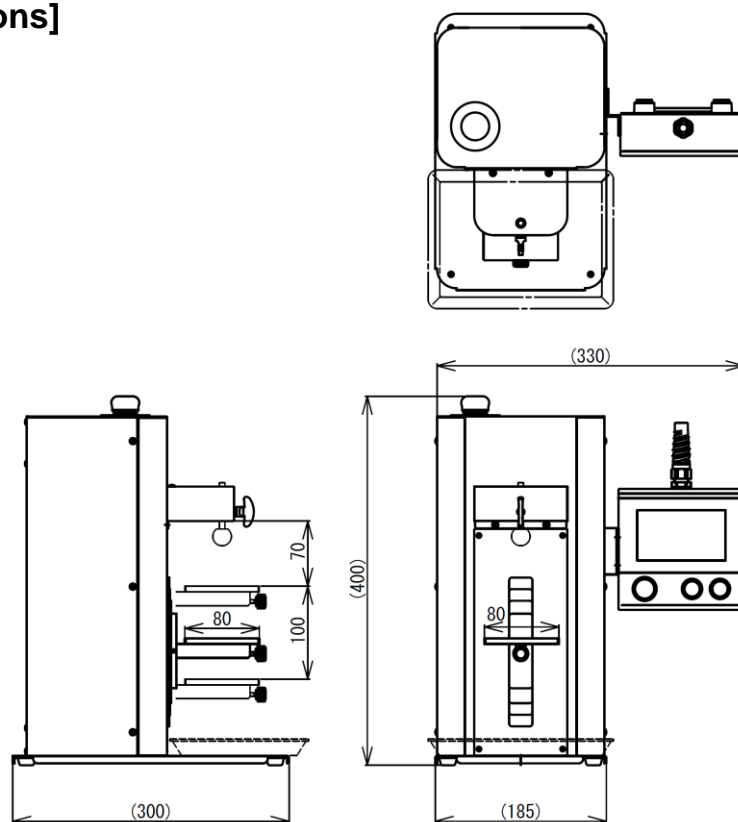

[Cautions]

- The contents may be changed without previous notice.
- All of the products are designed for measurement purpose only.
- Included software is protected by Japanese Copyright Law and the international treaty. Do not copy / distribute a part / all of contents.
- Do not copy and use this content without authority.

Feel free to contact us if you have any concerns. Our service gr: [+81-\(0\)532-33-3288](tel:+81-0532-33-3288)