

High functioning/High performance Digital Force Gauge ZT Series

High sampling rate: Captures force value more precisely.

Multifunction and easy set up with languages.

New I/O function: Continuous data saving in USB memory stick, displacement input and more.

[Judgment LED]
- Comparator function: Judges whether OK or NG regarding selected value.

[Internal performance/Control panel]
- High sampling rate (Max.2000 data/sec):
High sensitivity.
- Internal 1000 points data memory

[Data Transmission]
- Draws graph smoothly with USB transmission. (Software is necessary)

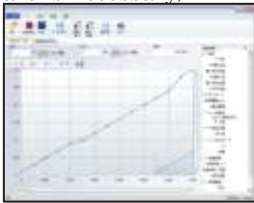

ZTA special feature
- Able to save continuous data in USB memory stick (USB memory stick is not included.)
- Force-displacement measurement is possible due to displacement I/O functions



[Measurement part]
- Combining with attachment, it can measure tension/compression/peel force etc.

[Display]
- Clear high brightness display (Organic EL)
- Easy set up with languages.

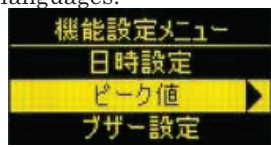

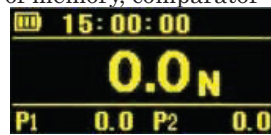

- You can select indication from date and time, the number of memory, comparator value and more.



ZTA special feature
- Indicates 2 peak values (2 steps) . (Ideal for measuring switch's peak of the point of contact)
- Indicates displacement. (Necessary to be combined with test stand having linear scale.)

<< The front of ZTA
* ZTA-2500N,5000N have different shape.
* ZTS series are different in design of control panel from ZTA series.
<< The bottom of ZTA (Connector part)

[Example of Use]

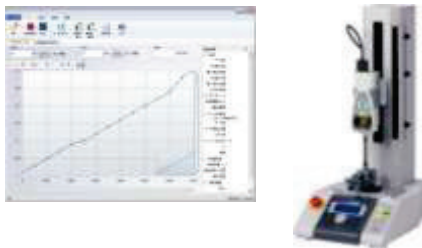
Hand held use	More precise force measurement	Force-displacement measurement
You can measure tension/compression force by hands as a simplified.	Combining with a test stand, more precise measurement becomes possible since test stand provides consistent test speed and direction.	Combining with a test stand having linear scale and software, force-displacement characteristic test is possible.
		

[ZT series Specifications]

You can select from 2 types (ZTA or ZTS) in accordance with your use.

Model	ZTA	ZTS
Feature	Advanced model with various functions such as data saving in USB memory stick, displacement I/O and more.	Standard model with the same benefit in performance as ZTA series but reduced functions.
Accuracy	+/-0.2%F.S.+/-1digit	
Unit of measurement(*1)	N, kgf, lbf (*2)	
Display	4-digit Organic EL	
Display update	10 / sec	
Sampling rate	2000 data / sec at maximum (*3)	
Battery	8 hours (8 hours charge)	
Safe overload rating	Approx.200%F.S.	
Operating environment	Temperature: 0 to +40 degree Celsius, Humidity: 20 to 80%RH	
Function	Customized display (header and footer), Peak hold (tension and compression), Internal 1000 points data memory, Comparator (judgment of OK or NG), Reversible display, Sign inversion, Zero clear timer, +NG alarm, Off timer (auto power off), Dumping, Calendar display	
	1 st /2 nd peak, Displacement detection at force peak, Displacement reset at selected force	-
Output	USB, RS232C, Mitutoyo digimatic (*4), 2 VDC analog output (D/A), Comparator 3 steps (-NG/OK/+NG)	
	Sub comparator 2 steps (output of large or small judgment)	-
Overload warning	Approx.110%F.S. (Warning message and alarm)	
External connecting switch	SEND (a point of contact holding), Zero reset, Peak ON/OFF setting	
Weight	From 2N to 1000N model: Approx.490g (*5) 2500N, 5000N: Approx.1100g (*5)	
Dimensions	Please refer to dimensions.	
Accessory(*6)	AC adapter, Inspection certificate, CD driver (including simple software for data logging), Attachments (The set of attachments varies according to range.), USB cable, Carrying case.	
	Adapter for USB memory stick	-

*1 This is the specifications for International model. Please note that available unit is different from Japanese domestic model and international one.

*2 [N indication] The indication of 2N and 5N models is mN or N. The indication of 1000N,2500N and 5000N model is N or kN.
[kgf indication] The indication of 2N and 5N models is gf.
[lbf indication] The indication of 2N and 5N models is ozf.

*3 When you save data in USB memory stick, the sampling rate is 100 data/sec.

*4 It is not always available for Mitutoyo digimatic products.

*5 Weight is slightly different according to range.

*6 USB memory stick is not included.

[ZT series Range]

Model		Range	Display	Resolution	Thread	Included attachment	
ZTA-2N	ZTS-2N	2N(200gf)	2.000N/2000mN (200.0gf)	0.001N/1mN (0.1gf)	M6	A1-A8	
ZTA-5N	ZTS-5N	5N(500gf)	5.000N/5000mN (500.0gf)	0.001N/1mN (0.1gf)			
ZTA-20N	ZTS-20N	20N(2kgf)	20.00N(2.000kgf)	0.01N(0.001kgf)			
ZTA-50N	ZTS-50N	50N(5kgf)	50.00N(5.000kgf)	0.01N(0.001kgf)		M6	S1-S8
ZTA-100N	ZTS-100N	100N(10kgf)	100.0N(10.00kgf)	0.1N(0.01kgf)			
ZTA-200N	ZTS-200N	200N(20kgf)	200.0N(20.00kgf)	0.1N(0.01kgf)			
ZTA-500N	ZTS-500N	500N(50kgf)	500.0N(50.00kgf)	0.1N(0.01kgf)		M10	RS1, S2-S8
ZTA-1000N	ZTS-1000N	1000N(100kgf)	1000N/1.000kN (100.0kgf)	1N/0.001kN (0.1kgf)			
ZTA-2500N	ZTS-2500N	2500N(250kgf)	2500N/2.500kN (250.0kgf)	1N/0.001kN (0.1kgf)			
ZTA-5000N	ZTS-5000N	5000N(500kgf)	5000N/5.000kN (500.0kgf)	1N/0.001kN (0.1kgf)	M10	B1-B8	

[Accessory]

<p>Data logger Simple software ZT-Logger</p>	<p>Main functions</p> <ul style="list-style-type: none"> - Captures peak data (*1) - Captures continuous data (10 data /sec) (*1) - The call of memory data (*1) - Saves data in CSV format <p>Operating environment</p> <ul style="list-style-type: none"> - OS: Windows XP/Vista/7(32bit/64bit) - CPU: more than 1GHz - Memory: more than 1GB - Hard disk : more than 2GB - .NET Framework4 later <p>*1 Available data: Force / Displacement (Necessary to be combined with a test stand having linear scale) / Time</p> <p>*2 Please note that there is some possibility of not working in particular environment.</p>	<p>* The image is one under developing.</p>
<p>Attachment</p>	<p>Accessory attachment</p> <p>>> Please refer to ZT series Range above.</p> <p>*The set of attachments varies according to range. *For more information, please refer to Standard attachment specifications.</p>	<p>Accessory attachments' shape. (an excerpt)</p> <p>S-1 Small hook S-2 Disk shaped S-3 Conical shaped S-6 Extension rod S-7 Large hook</p>

[Option]

Option	Explanation	Model
Analog voltage (Sensor raw data)	To output sensor data as fast analog voltage without conversion. *The speed is higher than D/A (standard), but there are demerits at the same time that zero reset is not possible, and there are many noises. *CB-118 cable is necessary.	-AN





[Application of Force Gauge]

ZT series enable...

1. Controlling external equipment according to force value. (e.g. To stop or change operation of machine at selected force value.)
2. Adding load at a certain force value. (e.g. To hold down sample at a certain force value.)
3. Producing inspection device synchronized with work process. (e.g. To improving efficiency of inspection process.)
4. Finding inferior goods earlier with comparator (judgment of acceptance or rejection) function.(e.g. To do quality control thoroughly)

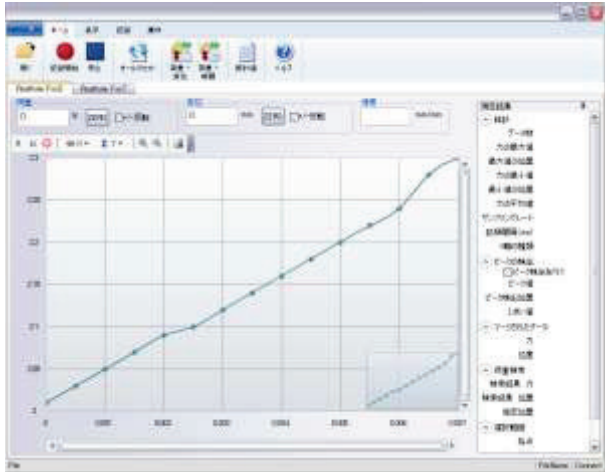
>> Please contact us or our distributor in your country for more information.

[Related Products]

Graphing Software: Force-Recorder				
 <p>*The image is one under developing.</p>	You can select from 3 grades.			
	Main functions	Professional	Standard	Light
	Force-time graphing Sampling rate: Max. 2000/sec	✓	✓	✓
	Force gauge function setting	✓	✓	✓
	Data storage in CSV format	✓	✓	✓
	5 graphs at maximum can be displayed in a table	✓	✓	N/A
Force-displacement graphing	✓	N/A	N/A	
*Professional version needs ZTA and a test stand with linear scale. *Please refer to each specifications for more information.				
Printer:DP-1VR	Optional Handles: FOH-1	Battery: BP-308		
				
Prints indicated values and data in internal memory. CB-308 cable is necessary.	You can grip handles firmly so it becomes easier to apply high load force steadily.	Battery for replacement.		

[Related Cable]

Model	Explanation	Purpose of use
CB-108	Analog cable	To connect multi meter, oscilloscope.
CB-118	Analog cable (For -AN option)	To connect multi meter, oscilloscope.
CB-208	RS232C cable	To connect PC having its own system
CB-308	Digimatic cable	To connect printer DP-1VR
CB-508	Test stand option cable (For MX)	To connect a test stand to enable force control or overload prevention functions.
CB-518	Test stand option cable (For MX2,EMX)	To connect a test stand to enable force control or overload prevention functions.
CB-718	Test stand connection cable for displacement measurement (For MX2-FA)	To connect a test stand having length meter to enable force-displacement measurement.
CB-728	Test stand connection cable for displacement measurement (For EMX-FA)	To connect a test stand having length meter to enable force-displacement measurement.
CB-908	Open end connection cable	Output cable for loose wire 37 pin (Useful for connection with unique equipment.)

[Sensor Separate Model]

Applicability of force gauge becomes wider, combining with external sensor (load cell).

Sensor separate type can meet your measurement needs such as

- You need to measure in limited place.
- You need to measure at the place away from you.
- You would like to use special load cell

Please refer to Sensor separate model specifications for more information.



[Load cells that can be combined with sensor separate model force gauge]

Model	DPU series	LM series	LMU series	Others
Feature	Shaped to fit for mounting on your external equipment easily. For both compression and tension.	A coin shaped and thin load cell for compression.	Small load cell for both compression and tension.	LU series LC series WP-50N LMT-1000N PN-50N TMS series DM-2000N
Range	2N to 20kN	10N to 20kN	50N to 500N	
Accuracy	+/-0.2%F.S.	+/-1 to 2.5%F.S.	+/-1%F.S.	
Image				

* Please refer to each specification for more information about load cell.

[Dimensions: From 2N to 1000N]

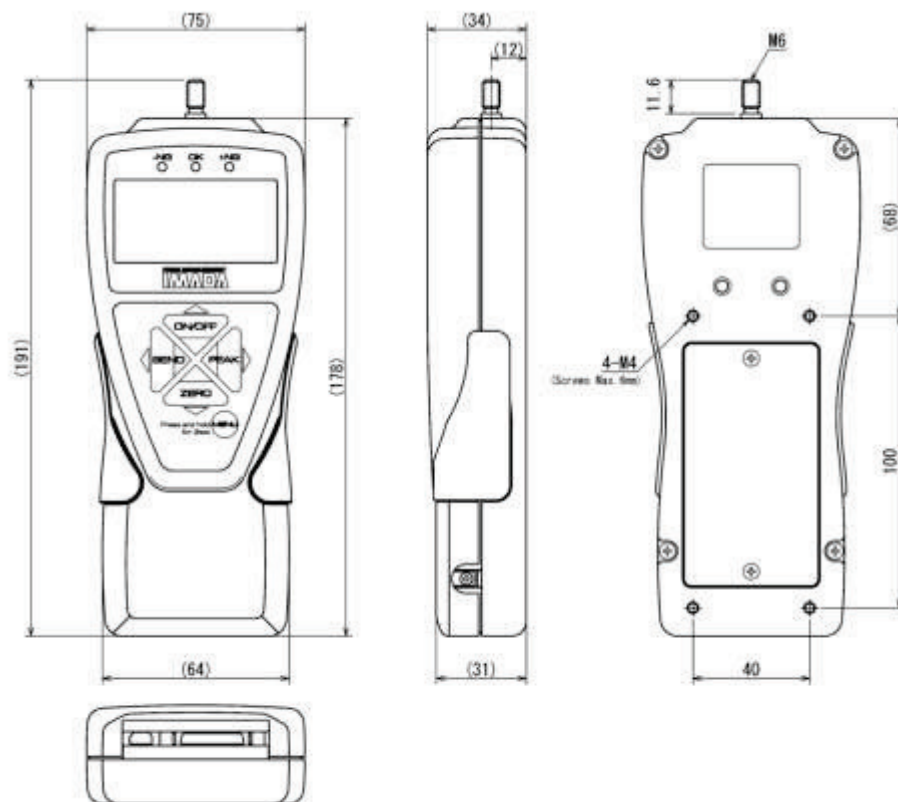

[Dimensions: 2500N to 5000N]

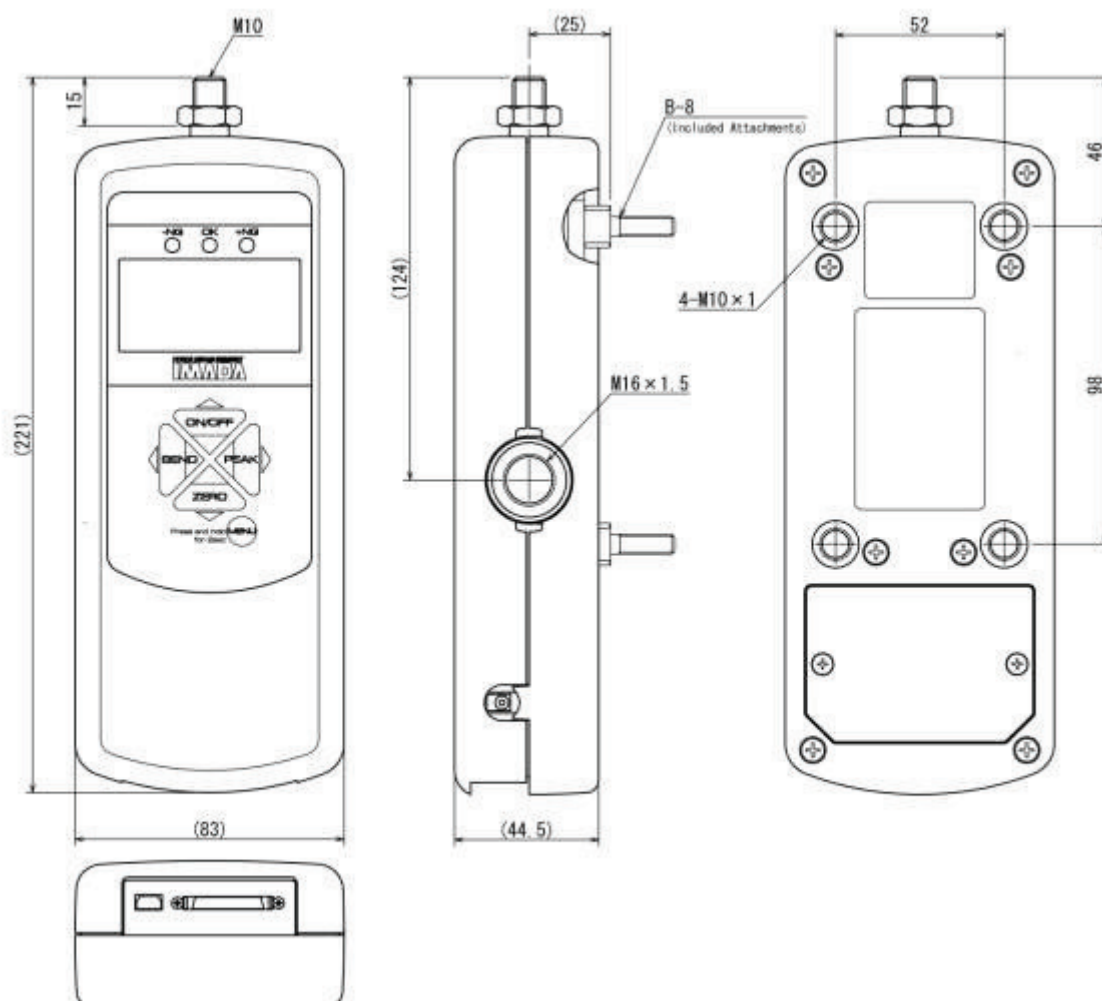

[Calibration Certificate]

We offer calibration certificate with extra charge.

* Please contact us or our distributor in your country for more information.

[Cautions]

- The contents may be changed without previous notice.
- All of products are designed for measurement purpose only.
- Do not copy and use this content without authority.